

Article number: 432000180  
 Description: Rota-fix shaft-hub connection A 180x235  
 Steel  
 Note: Not self centering. Medium-high torques.

## Measures

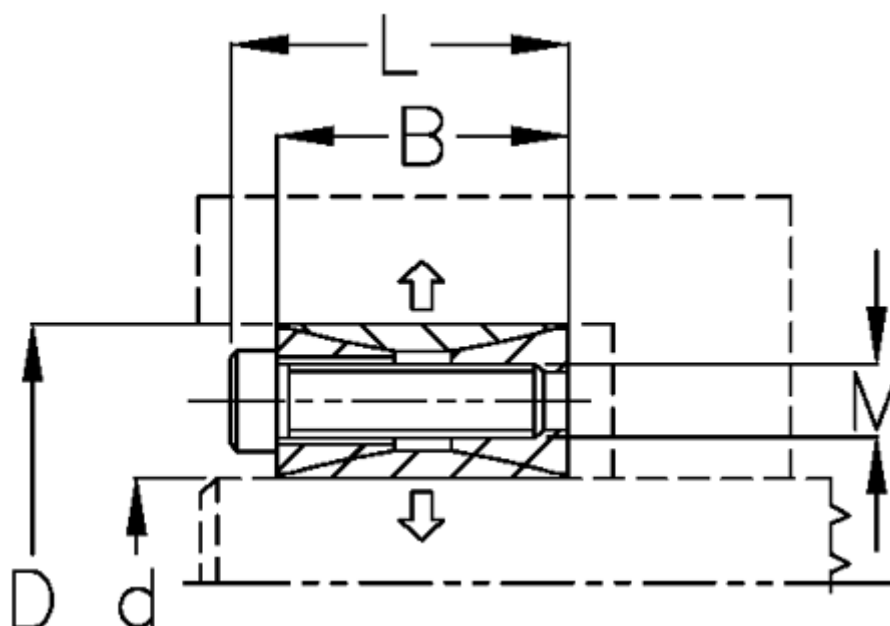

B mm	= 44
d H8 mm	= 180235
D mm	= 235
Fit tolerance	= Aksel k11-h11, Nav N11-H11
F kN torque	= 473.0
L mm	= 58
M mm	= M14
P N/mm <sup>2</sup> surface pressure on shaft/hub	= 141

Surface roughness	=
T N m torque	=
Ts N m bolt tightening torque	=